

vinyl design

**ULTRAVIEW
PATIO DOOR
7500 SERIES**

ALL PVC
WITH WELDED SASH

**A TRADITION OF
EXCELLENCE
SINCE 1988**

THE QUIETEST, MOST THERMALLY
EFFICIENT DOOR AVAILABLE ON
THE MARKET TODAY.

STANDARD FEATURES

DESIGNED TO WORK LIKE A CHARM—WITH VINYL DESIGN PERFORMANCE THAT'S BUILT TO LAST

SMOOTH AND QUIET

These doors slide open smoothly and quietly thanks to:

- Patented dual-tandem nylon wheels
- A raised rail to protect the wheels from dirt and debris

Sturdy all-aluminum angle-legged tracks

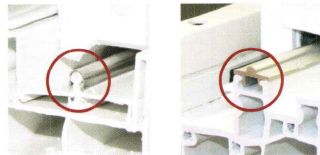

Competition

Vinyl Design

- Perfectly straight and carefully adjusted parts to minimize friction and make for smoother operation

MULTICHAMBER DESIGN

Our multichamber design reduces thermal exchange and, with more enclosed air space than other brands, increases insulation values—without the addition of costly, less recyclable insulating material.

THE SOUND OF SILENCE

Shhhh... Enjoy the sound of silence! Multichamber profiles and multiple weatherstripping help eliminate most outside noise.

INCREASED PROTECTION

Fixed and mobile panel rails meet and interlock perfectly, making removal from outside almost impossible. Lower sill design provides safer entry and exit.



INSTALLER-FRIENDLY DESIGN

Installer-friendly design and room for panel adjustment mean uneven surfaces are never a problem—it's a snap to plumb and square Vinyl Design Doors.

OUTSTANDING RELIABILITY

Engineered to perform at PG60 levels at all sizes up to 70-7/8" x 81-7/8", this door provides reliability that will stand the test of time, and is particularly watertight.

Try the VDC fingertip test: bet you can open this door with just the tip of a finger! The easiest door to operate in its category.

OPERATING FORCE TEST

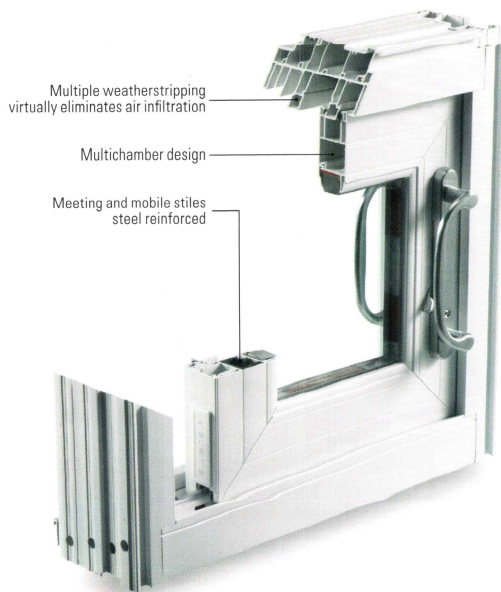
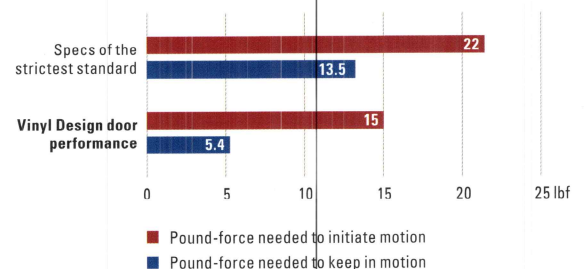

CONSERVATION

We're into Conservaction®!

Our patio doors not only offer unique and distinctive technical features—they're also all specially designed to save energy and preserve natural resources. Longer product life, and the best energy performance in the industry!

UNPRECEDENTED ENERGY EFFICIENCY!

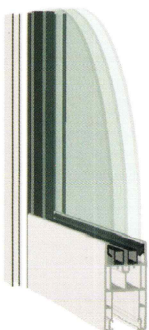
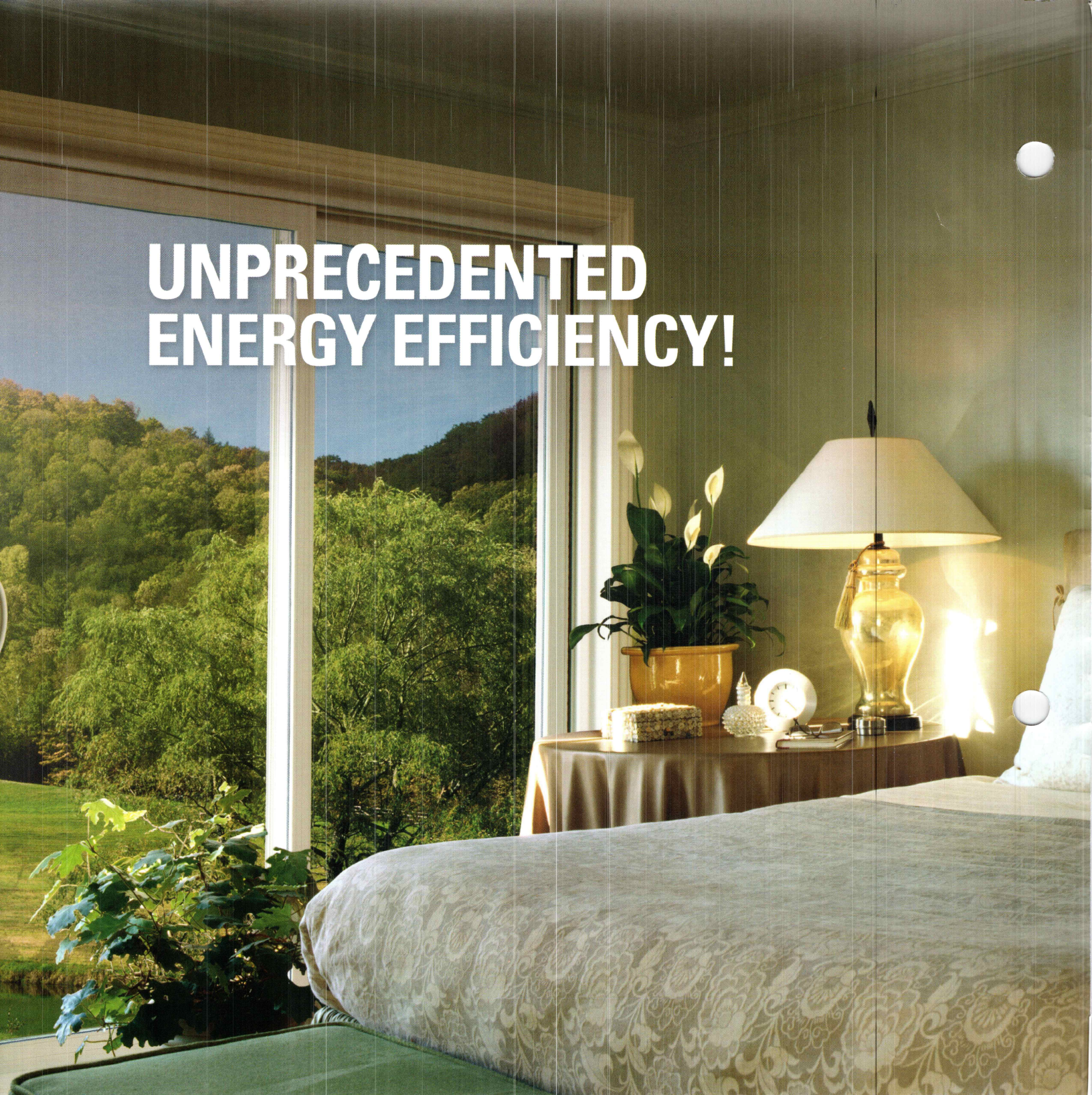

- Performance that meets the highest standards in terms of energy efficiency and meets the latest Canadian and American energy standards.
- Design that allows for optional 1"-thick triple-glazed sealed units, with or without integrated aluminum blinds.
- Efficient division between the glass and steel reinforcement, reducing significantly the risks of condensation.

CLEARLY THE HIGHEST VALUE FOR YOUR MONEY.

HAVE IT YOUR WAY!

CUSTOMIZATION

MULTIPLE CONFIGURATIONS

This patio door series is available in 2-panel, 3-panel and 4-panel configurations, with a wide range of energy-smart glazing options and decorative grilles.

CHOICE OF COLORS

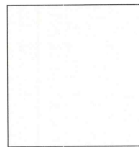

Cream White

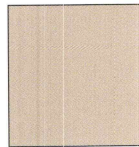

Beige

INTERIOR LAMINATED FOILS



Light oak

Dark oak

Cherry oak

PREMIUM HEAVY DUTY SCREEN

It's smooth with our heavy duty aluminum screen. The aluminum screen is equipped with patented spring-loaded rollers, are fully adjustable at each corner, to prevent bothersome derailing.

CHOICE OF HANDLES

All locking mechanisms are encased in galvanized steel reinforcement.

Round-shaped metal handles are offered with interior/exterior grip.



Black nickel

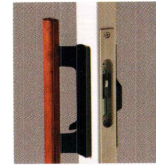

Wood



Black



White



Brushed chrome
(Also available in bright chrome)



Brass

MULTIPOINT LOCKING SYSTEM

A multipoint locking system (optional) provides optimum resistance and security to forced entry.

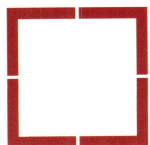
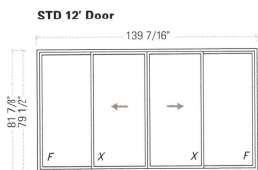
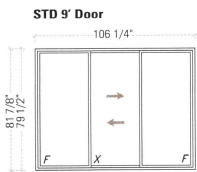
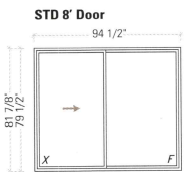
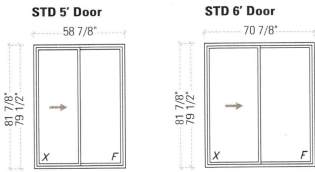

vinyl design

VINYL DESIGN CORPORATION

7856 Hill Avenue
Holland, OH 43528

vinyldesigncorp.com

PH : 800.469.4009
PH : 419.865.4009
Fax : 419.865.4453

LIFETIME SYSTEM WARRANTY

Vinyl design offers lifetime warranty on door units, glass breakage, seal failure and hardware.

S-7500 All-PVC sliding door

Size tested (in.)	Harmonized Standard
70 7/8 x 81 7/8	R-PG60-SD
96 x 96	LC-PG35-SD